

## DC500

## Door closer with Cam-Motion® technology and guide rail



## ASSA ABLOY DC500

- Available with height-adjustable guide rail G195 or standard guide rail G193
- Fulfills barrier-free building requirements (DDA/ CEN TR 15894)
- Certified in compliance with EN 1154, size 1-4
- Suitable for fire and smoke protection doors
- For single action doors up to 1100 mm wide
- Can be used in four installation types: hinge and non-hinge sides in standard and frame installation

## Characteristics for DC500

- Can be used with integrated concealed mounting plate, suitable for fire and smoke protection doors
- Can be used for left and right-handed doors
- Axis continuously height adjustable up to 14 mm
- Closing speed, latching speed and backcheck adjustable via front facing regulating valves
- Thermodynamic valves for consistent performance
- Variable adjustable closing force
- Opening angle up to 170°
- Effective backcheck and latching speed range adjustable
- Large range of applications
- Standard colours: silver EV1; white, similar to RAL9016; brown, similar to RAL8014; black, similar to RAL9005, stainless steel
- Customised finishes available on request



CE	Abloy OY	13
	PO Box 108 80101 Joensuu, Finland	
1162-CPD-0629	EN 1154:1996+A1:2002	3 8 4 1 1 4

## Characteristics for guide rail G195

- Height-adjustable by 2 mm for tolerance
- Concealed fastening screws
- Installation dimensions: see diagram

## Characteristics for standard guide rail G193

- Without protective cover
- Visible fastening screws
- Installation dimensions: see diagram (dimensions in brackets)

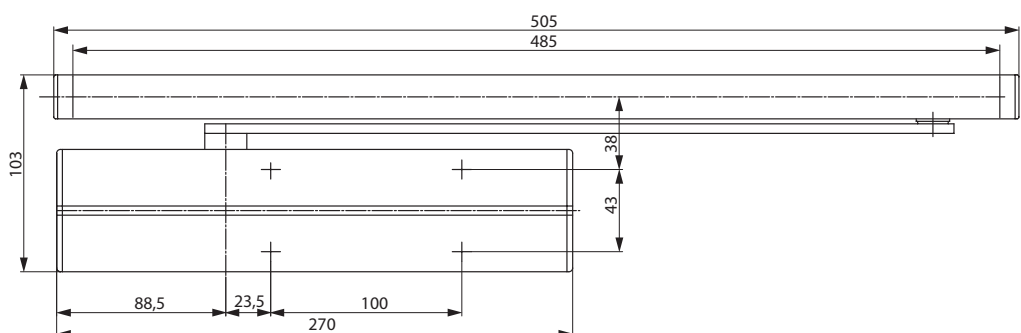
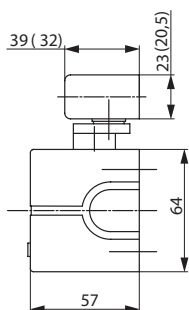

# DC500

## Technical attributes

Technical attributes	
Variable adjustable closing force	EN 1-4
Door width up to	1100 mm
Fire and smoke protection	yes
DIN door swing directions	left / right handed
Standard and frame installation	yes
Closing speed	Variable between 170°-10°
Latching speed	Variable between 10°-0°
Backcheck	Variable above 75°
Opening angle hinge side	ca. 170°
Opening angle non-hinge side	ca. 120°
Weight	2.7 kg
Height	64 mm
Depth	57 mm
Width	270 mm
Certified in compliance with	EN 1154
CE marking for building products	yes

Our service for you: here you can see the individual advantages of our door closer models for your respective field of business.

### The advantages at a glance

Customer segment	Advantages
Project planners	<ul style="list-style-type: none"> <li>- Extensive range of uses: Fire and smoke protection doors as well as standard doors</li> <li>- Modern design</li> <li>- Compact design</li> <li>- Fulfils barrier-free building requirements (DDA, CEN/TR 15894)</li> <li>- Same dimensions and design with and without mounting plate</li> </ul>
Builders	<ul style="list-style-type: none"> <li>- One drilling template overall</li> <li>- Adjustable to nearly all door and frame types</li> <li>- Quick and easy installation</li> <li>- Quickly and easily adjustable</li> <li>- Suitable for left and right handed doors for standard and frame mounting on hinge and non-hinge side</li> </ul>
Trade	<ul style="list-style-type: none"> <li>- Reduced inventory costs due to modular product range</li> <li>- One single product suitable for a large variety of mounting positions</li> <li>- Complementary accessories available for the whole product range</li> </ul>
User	<ul style="list-style-type: none"> <li>- Largely unaffected by temperature fluctuations thanks to thermodynamic valves</li> <li>- Easier door opening and improved accessibility due to rapidly decreasing torque</li> </ul>

### Specifications for DC500

- ASSA ABLOY Door Closer DC500 with Cam-Motion® technology and guide rail in compliance with EN 1154
- Closing power continuously adjustable, EN size 1-4, for doors up to 1100 mm wide
  - Closing speed, latching speed and backcheck continuously adjustable
  - Can be used with integrated concealed mounting plate, suitable for fire and smoke protection doors
  - CE approved
  - 14 mm height adjustable arm system for ease of fitting
  - Standard and frame mounting on hinge and non-hinge side of the door
  - Suitable for left and right handed doors

#### Accessories:

- Standard guide rail G193
- Height-adjustable guide rail G195
- Mounting plate A120
- Mounting plate A130 for guide rail G193 and G195
- Angle bracket A104 for guide rail G193
- Mechanical opening damper A153
- Mechanical hold open device A152 (not for fire and smoke protection doors)
- Glass door shoe A166

#### Colour:

- Silver EV1
- White, similar to RAL9016
- Brown, similar to RAL8014
- Black, similar to RAL9005
- Stainless steel
- Customised finish

You can find the complete specifications on the Internet at: (Link of your companies homepage)

# DC500

## Dimensional drawings

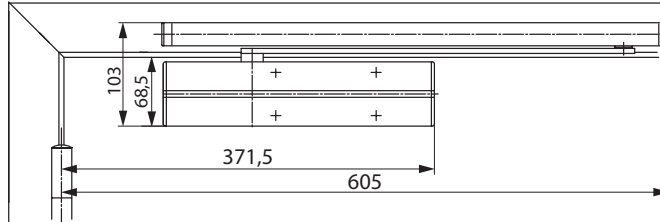
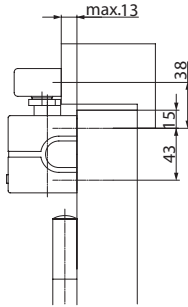

Space required on doors for standard installation on hinge side  
 Left handed shown in diagram  
 Right handed is the reverse

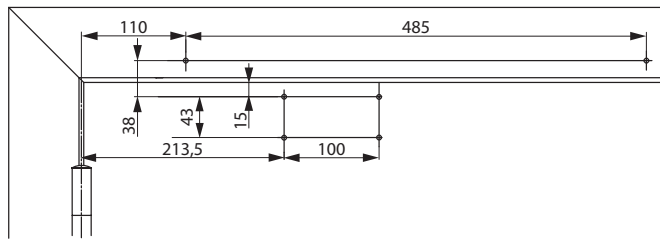
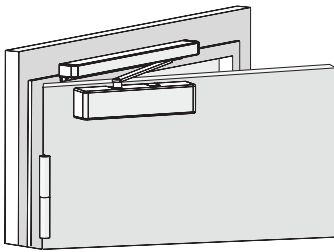

Installation dimensions for direct standard mounting on hinge side  
 Left handed shown in diagram  
 Right handed is the reverse

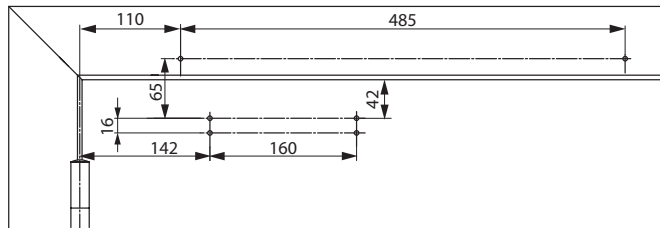

Installation dimensions with mounting plate for standard mounting on hinge side  
 In compliance with EN 1154, Supplement 1, or for doors where direct mounting is not possible.  
 Left handed shown in diagram  
 Right handed is the reverse

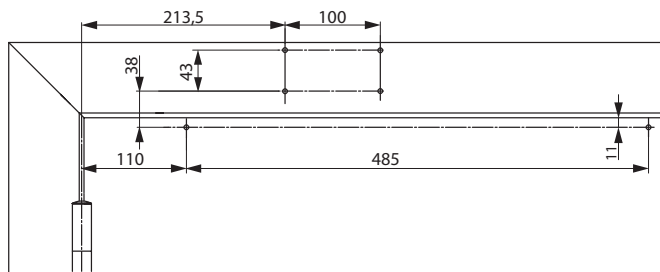
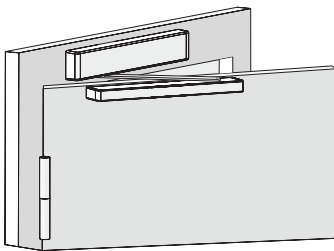

Installation dimensions for direct frame mounting on hinge side  
 Closer on hinge side of door frame.  
 Left handed shown in diagram  
 Right handed is the reverse

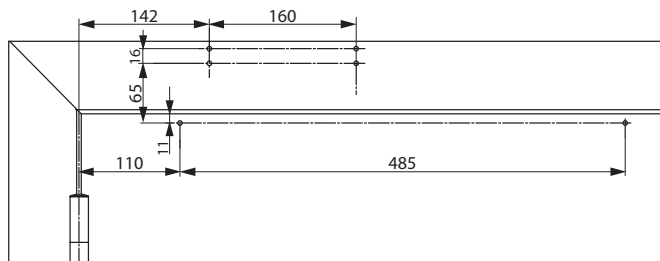

Installation dimensions with mounting plate for frame mounting on hinge side  
 Closer on hinge side of door frame. For doors where direct mounting is not possible.  
 Left handed shown in diagram  
 Right handed is the reverse

## Dimensional drawings

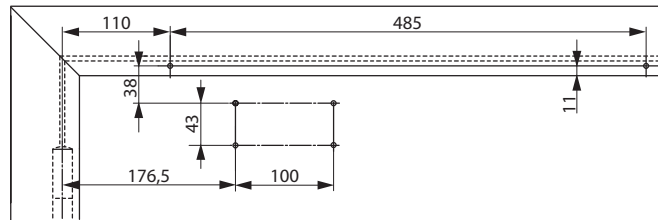
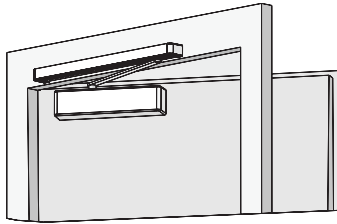

Installation dimensions for direct standard mounting non hinge side  
Right handed door shown in diagram  
Left handed door is the reverse

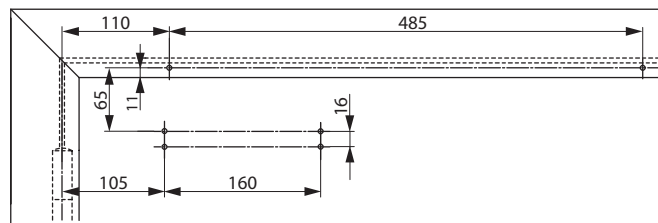
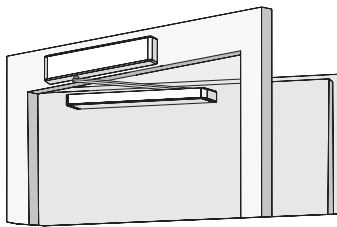

Installation dimensions with mounting plate for standard mounting non hinge side  
For doors where direct mounting is not possible  
Right handed door shown in diagram  
Left handed door is the reverse

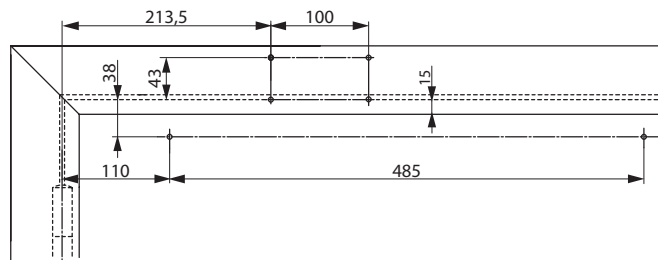

Installation dimensions when mounted directly onto the frame non-hinge side  
Closer on non-hinge side of door frame  
Right handed door shown in diagram  
Left handed door is the reverse

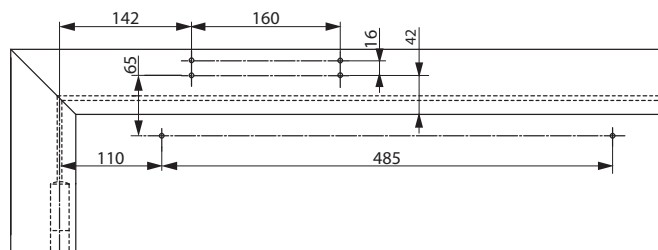

Installation dimensions with mounting plate for frame mounting non-hinge side  
Closer on non-hinge side of door frame. For doors where direct mounting is not possible.  
Right handed door shown in diagram  
Left handed door is the reverse

# DC500 Accessories

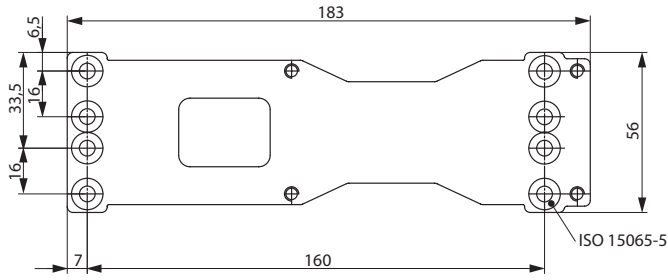
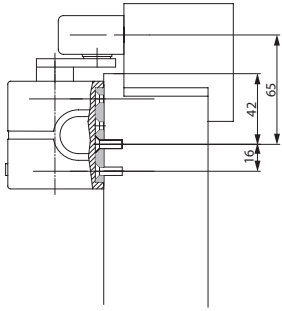

**Mounting plate A120**  
For mounting with drilling template acc. to EN 1154 Supplement 1 and for universal use

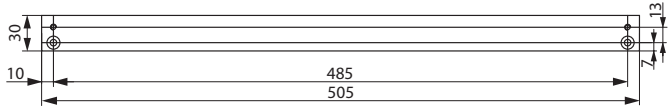
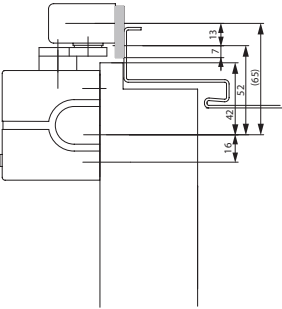

**Mounting plate A130**  
For guide rail G193 and G195

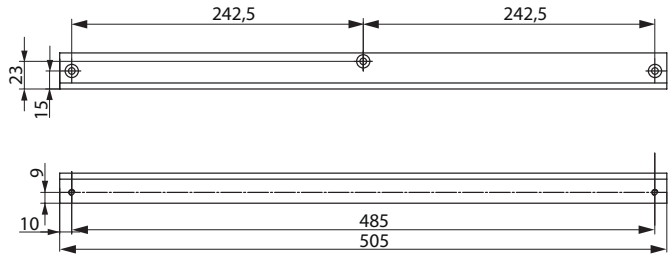
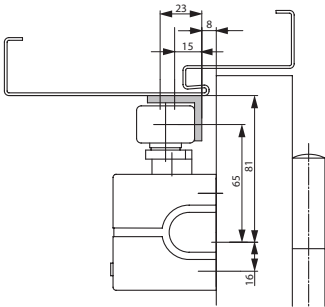

**Angle bracket A104**  
Only for standard guide rail G193

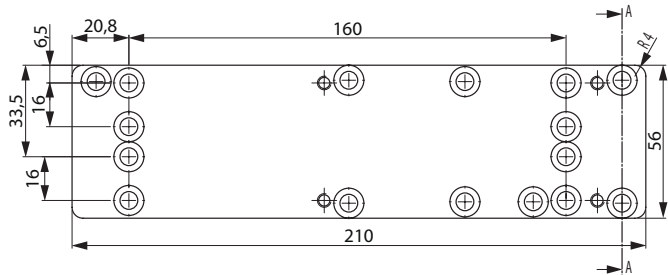
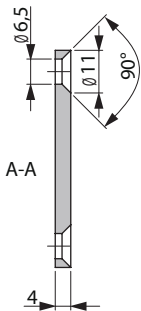

**Replacement plate A124**  
For renovation applications

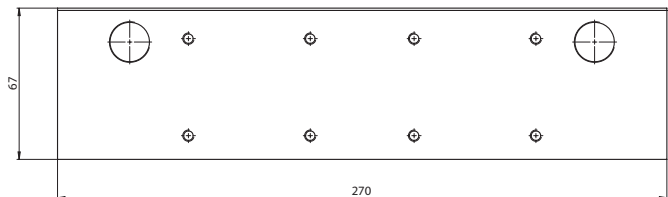
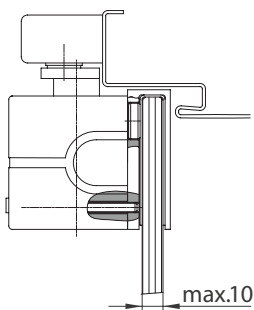

**Glass door shoe A166**  
For mounting the door closer on the all-glass door leaf.

## DC500

## Accessories and order placement information

DC700 / DC500 with stainless steel, full cover



DC700 / DC500 with stainless steel, ASSA ABLOY design



#### Hold open device A152

Mechanical hold-open device for doors which sometimes need to be secured in the open position.

Simple fitting into guide rail G193 and G195.

Hold open angle max. 130°

Adjustable hold-open force

Not approved for use on fire and smoke protection doors.

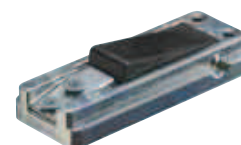

#### Opening damper A153

Helps to prevent the door and door handle from hitting a return wall.

Simple fitting into guide rail G193 and G195.

Opening damper continuously adjustable up to an opening angle of max. 130°.

Does not replace a door stop.

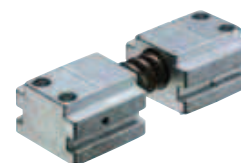

Description	Order no.	Description	Order no.
DC500, EN size 1-4, silver EV1		Guide rail G195, bespoke finish	
DC500, EN size 1-4, white, similar to RAL9016		Mounting plate A120, galvanised	
DC500, EN size 1-4, brown, similar to RAL8014		Mounting plate A130, silver EV1	
DC500, EN size 1-4, black, similar to RAL9005		Mounting plate A130, white, similar to RAL9016	
DC500, EN size 1-4, stainless steel, ASSA ABLOY design		Mounting plate A130, brown, similar to RAL8014	
DC500, EN size 1-4, stainless steel, full cover		Mounting plate A130, black, similar to RAL9005	
DC500, EN size 1-4, stainless steel, customised finish		Mounting plate A130, customised finish	
Guide rail G193, silver EV1		Replacement plate A124, galvanised	
Guide rail G193, white, similar to RAL9016		Mounting plate A136, non-hinge side, for Guide Rail G193 and G195, 40 mm, silver EV1	
Guide rail G193, brown, similar to RAL8014		Glass door shoe A166, silver EV1	
Guide rail G193, black, similar to RAL9005		Angle bracket A104, silver EV1	
Guide rail G195, silver EV1		Angle bracket A104, RAL9016 white	
Guide rail G195, white, similar to RAL9016		Angle bracket A104, brown, similar to RAL8014	
Guide rail G195, brown, similar to RAL8014		Angle bracket A104, black, similar to RAL9005	
Guide rail G195, black, similar to RAL9005		Hold open device A152	
Guide rail G195, stainless steel		Opening damper A153	